

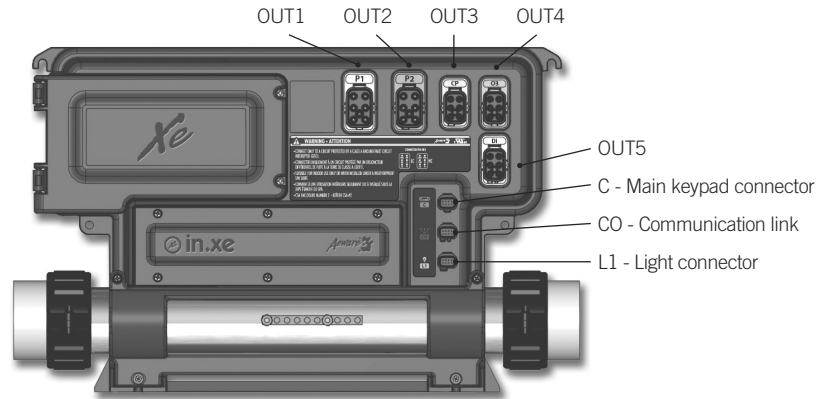

Quick Start Card

in.xe-5™ North American version

1- Connect all outputs & keypads



Don't forget that the voltage is determined by the cable used (120 or 240 V cable)!

2- Connect the main power

2.a- Electrical wiring

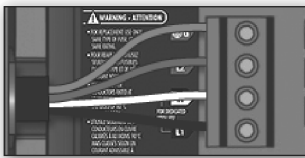

For 240 V (4 wires)



For 120 V (*3 wires)

* If connected to a 3 wire system all 240 V components will not work.

WARNING! All connections must be made by a qualified electrician in accordance with the national electrical code and any state, provincial or local electrical code in effect at the time of the installation. This product must always be connected to circuit protected by a Ground Fault Circuit Interrupter (GFCI).

2.b- Heater voltage

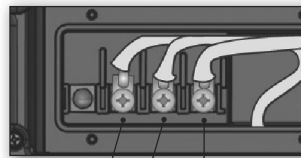

Connection for 240 V / heater (4 kW)

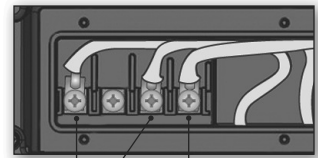

Connection for 120 V / heater (1 kW)

The heat.way heater is factory configured 240 V/4 kW (or 2 kW), but it can be converted to a dedicated 120 V / 1 kW by a simply switching the cable connection port. Option available on North American models only.

Heat.way specification summary:

- Supports 120 V or 240 V
- Protected by external breaker (not fused)
- Incoloy® or Titanium (optional) heater element for greater protection against corrosion.

3- Select spa configuration (see chart next page)



At first startup the keypad display will show **L 1** or **LL 1**.

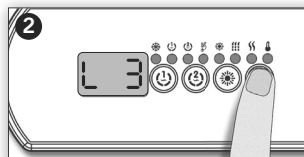

Use the **Up/Down** key to choose the new low level configuration number.

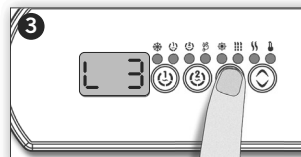

Press the **Program** key to confirm the selection.

Note: To re-enter the Low level selection menu, hold the **Pump 1** key for 30 seconds.

Note: If the keypad does not have a **Program** or **Filter** key, use the **Light** key instead.

Note: For the **Color keypad series**, select **Settings menu**, go into **Electrical config** and choose the appropriate Low level.

4- Select breaker current

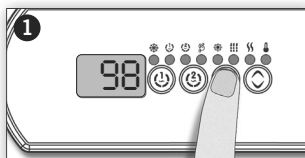

Press and hold the **Program** key for 20 seconds until you access the breaker setting menu.

Note: For the **Color keypad series**, select **Settings menu**, go into **Electrical config** and choose Input current.

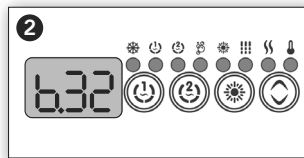

The values displayed by the system correspond to 80% of the maximum amperage capacity of the GFCI.

For more information, see our website: www.geckoalliance.com

GFCI	b
60 A	48 A
50 A	40 A
40 A	32 A
30 A	24 A
20 A	16 A
15 A	12 A

(10 to 20 A dedicated to 120 V)

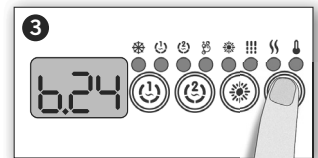

Use the **Up/Down** key to select the desired value. Then press the **Program** key to confirm the selection.

Note: If the keypad does not have the **Program** or **Filter** key, use the **Light** key instead.

For more information, see our website: www.geckoalliance.com



Configuration selection chart

Software #299, rev. 002

Standard config. #	Pump 1	Pump 2	Pump 3	Pump 4	Pump 5	Blower	DIRECT 1	DIRECT 2	Circ. Pump (CP) configuration	Ozone (O3) configuration ¹	Filter cycle daily	Heater
1	2SP (OUT1) 12A-4A	-	-	-	-	-	X (OUT5) 1A	-	-	On filter cycle (OUT4) 0A	2 * 2 hour with P1	with P1 17A
2	2SP (OUT1) 12A-4A	-	-	-	-	-	X (OUT5) 1A	-	On filter cycle (OUT3) 2A	On filter cycle (OUT4) 0A	2 * 6 hour with CP	with CP 17A
3	2SP (OUT1) 12A-4A	1SP (OUT2) 10A	-	-	-	-	X (OUT5) 1A	-	-	On filter cycle (OUT4) 0A	2 * 2 hour with P1	with P1 17A
4	2SP (OUT1) 12A-4A	1SP (OUT2) 10A	-	-	-	-	X (OUT5) 1A	-	On filter cycle (OUT3) 2A	On filter cycle (OUT4) 0A	2 * 6 hour with CP	with CP 17A
5	2SP (OUT1) 12A-4A	-	-	-	-	X (OUT3) 5A	X (OUT5) 1A	-	-	On filter cycle (OUT4) 0A	2 * 2 hour with P1	with P1 17A
6	2SP (OUT1) 12A-4A	-	-	-	-	X (OUT3) 5A	X (OUT5) 1A	-	On filter cycle (OUT4) 2A	-	2 * 6 hour with CP	with CP 17A
7	2SP (OUT1) 12A-4A	1SP (OUT2) 10A	-	-	-	X (OUT3) 5A	X (OUT5) 1A	-	-	On filter cycle (OUT4) 0A	2 * 2 hour with P1	with P1 17A
8	2SP (OUT1) 12A-4A	1SP (OUT2) 10A	-	-	-	X (OUT3) 5A	X (OUT5) 1A	-	On filter cycle (OUT4) 2A	-	2 * 6 hour with CP	with CP 17A
9	1SP (OUT1) 12A	-	-	-	-	-	X (OUT5) 1A	-	On filter cycle (OUT3) 2A	On filter cycle (OUT4) 0A	2 * 6 hour with CP	with CP 17A
10	1SP (OUT1) 12A	1SP (OUT2) 10A	-	-	-	-	X (OUT5) 1A	-	On filter cycle (OUT3) 2A	On filter cycle (OUT4) 0A	2 * 6 hour with CP	with CP 17A
11	1SP (OUT1) 12A	1SP (OUT2) 10A	-	-	-	X (OUT3) 5A	X (OUT5) 1A	-	On filter cycle (OUT4) 2A	-	2 * 6 hour with CP	with CP 17A
12	1SP (OUT1) 12A	1SP (OUT2) 10A	-	-	-	-	X (OUT5) 1A	-	-	On filter cycle (OUT4) 0A	2 * 2 hour with P1	with P1 17A
13	1SP (OUT1) 12A	1SP (OUT2) 10A	-	-	-	X (OUT3) 5A	X (OUT5) 1A	-	-	On filter cycle (OUT4) 0A	2 * 2 hour with P1	with P1 17A
14	2SP (OUT1) 12A-4A	1SP (OUT2) 10A	-	-	-	X (OUT3) 5A	X (OUT5) 1A	-	On filter cycle (OUT4) 2A	-	2 * 6 hour with CP	with P1 17A

Swim Spa config.

51	2SP Master (OUT1) 12A-4A	1SP Master (OUT2) 10A	1SP Slave (OUT1) 10A	1SP Slave (OUT2) 10A	-	-	X Master (OUT5) 1A	X Slave (OUT5) 1A	On filter cycle Master (OUT3) 2A	On filter cycle Master (OUT4) 0A	2 * 6 hour with CP	with CP 17A
52	2SP Master (OUT1) 12A-4A	1SP Master (OUT2) 10A	1SP Slave (OUT1) 10A	1SP Slave (OUT2) 10A	-	-	X Master (OUT5) 1A	X Slave (OUT5) 1A	-	On filter cycle Master (OUT4) 0A	2 * 2 hour with P1	with P1 17A
53	2SP Master (OUT1) 12A-4A	1SP Master (OUT2) 10A	1SP Slave (OUT1) 10A	1SP Slave (OUT2) 10A	-	X Slave (OUT3) 5A	X Master (OUT5) 1A	X Slave (OUT5) 1A	On filter cycle Master (OUT3) 2A	On filter cycle Master (OUT4) 0A	2 * 6 hour with CP	with CP 17A
54	2SP Master (OUT1) 12A-4A	1SP Master (OUT2) 10A	1SP Slave (OUT1) 10A	1SP Slave (OUT2) 10A	-	X Slave (OUT3) 5A	X Master (OUT5) 1A	X Slave (OUT5) 1A	-	On filter cycle Master (OUT4) 0A	2 * 2 hour with P1	with P1 17A
55	2SP Master (OUT1) 12A-4A	1SP Master (OUT2) 10A	1SP Slave (OUT1) 10A	-	-	-	X Master (OUT5) 1A	X Slave (OUT5) 1A	On filter cycle Master (OUT3) 2A	On filter cycle Master (OUT4) 0A	2 * 6 hour with CP	with CP 17A
56	2SP Master (OUT1) 12A-4A	1SP Master (OUT2) 10A	1SP Slave (OUT1) 10A	-	-	-	X Master (OUT5) 1A	X Slave (OUT5) 1A	-	On filter cycle Master (OUT4) 0A	2 * 2 hour with P1	with P1 17A
57	2SP Master (OUT1) 12A-4A	1SP Master (OUT2) 10A	1SP Slave (OUT1) 10A	-	-	X Slave (OUT3) 5A	X Master (OUT5) 1A	X Slave (OUT5) 1A	On filter cycle Master (OUT3) 2A	On filter cycle Master (OUT4) 0A	2 * 6 hour with CP	with CP 17A
58	2SP Master (OUT1) 12A-4A	1SP Master (OUT2) 10A	1SP Slave (OUT1) 10A	-	-	X Slave (OUT3) 5A	X Master (OUT5) 1A	X Slave (OUT5) 1A	-	On filter cycle Master (OUT4) 0A	2 * 2 hour with P1	with P1 17A
59 ²	1SP Master (OUT2) 12A	1SP Master (OUT1) 10A	1SP Slave (OUT1) 10A	1SP Slave (OUT1) 10A	1SP Slave (OUT2) 10A	-	X Master (OUT5) 1A	X Slave (OUT5) 1A	On filter cycle Master (OUT3) 2A	On filter cycle Master (OUT4) 0A	2 * 6 hour with CP	with CP 17A

Glossary

P1	Pump 1
CP	Circulation Pump
X	Installed
1SP	High speed only
2SP	High and Low speed
(OUT, AMP, Relay, Tab)	Output connector
12A, 12A-4A	Output current: 1 speed or High - Low speed

¹ When the Ozonator is not controlled by a relay, it can be tied to Pump 1 Low speed or Circ. Pump.

² Slave (OUT 1) high and low speed dedicated to Pump 3 and pump 4 respectively

